

# Universal Holding Frames & Latches

FOR GASKETED, MODULAR FILTERS

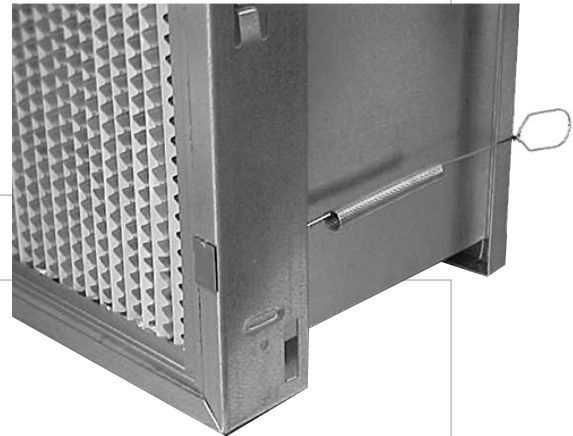

*The Universal frames are constructed of galvanized steel. Also available in 304 stainless steel and aluminized steel.*

## Universal Holding Frames

AAF Flanders Universal Holding Frames come in seven standard sizes that can be used individually or may be combined to fit virtually any size filter bank. Each frame includes a gasket to ensure a proper seal between the frame and filter to minimize dirty air bypass. Also included are AAF Flanders' unique holding latches, designed to hold the filter in place and create a positive seal. The latches are easy to use, requiring only a simple twisting motion to release the filter.

Universal Holding Frames are constructed of galvanized steel. The frames are available in 304 stainless steel, and there is an aluminized steel version for high temperature applications (note: 304 stainless and aluminized steel frames are slightly different in appearance but are of the same high quality and durability as the galvanized steel models). All frames feature holes on each side for bolting or riveting into filter banks.

Seven sizes are available: 24 x 24, 20 x 25, 20 x 20, 16 x 25, 16 x 20, 20 x 24, and 12 x 24. The 2<sup>1</sup>/<sub>16</sub>" deep frame will support all standard combinations of pre and final filters.

## High Temperature Applications

Filtration systems for paint curing ovens and other high temperature applications can be served by using an aluminized steel holding frame constructed without a gasket. The aluminized steel frame will tolerate temperatures up to 900°F. The standard gasket is good for temperatures up to 140°F.

## Filter Latches

AAF Flanders latches are available to hold a variety of filters and filter combinations, are replaceable, and are specifically designed for upstream or downstream servicing. Each latch is annealed to music wire specifications after forming, and commercially zinc plated to provide years of service under varying environmental conditions. The Universal Holding Frame sides feature a unique retaining tab to hold the "L" Series latches. "L" Series latches do not connect to, or disturb, the flat sealing flange and gasket surface.











The L-42 and L-44 latches, specifically designed for the VariCel® II filter in combination with prefilter, offer an additional advantage. The latch can be turned to release the prefilter while maintaining a pressure seal on the higher efficiency VariCel II filter.

## Conversion Latches

AAF Flanders sells "Knock On" latches to allow installation of all combinations of AAF Flanders filters in other manufacturers' filter holding frames.

# Universal Holding Frames & Latches

## Universal Frame Latch Selection

Final Filter	Prefilter	Service	Latch (Four latches recommended per frame.)
<b>1" Nominal or Header Filters</b> DriPak® VariCel® VariCel® V BioCel® 5700™ AmerFrame®	None	Upstream or Downstream	L-10 
	2"	Upstream	L-30 
	4"	Upstream	L-50 
<b>2" Nominal Filters</b> AmAir® 5700™ RenuFrame™ AmerFrame®	None	Upstream or Downstream	L-20 
	2"	Upstream	L-40 
<b>4" Nominal Filters</b> VariCel® II PREpleat®	None	Upstream or Downstream	L-40 
	2"	Upstream	L-42 
	4"	Upstream	L-44 
<b>12" Nominal Filters</b> DH VariCel® DH BioCel®	None	Upstream or Downstream	SL-12 
	2"	Upstream	SL-12 VP-2 
	4"	Upstream	SL-12 VP-4 

## Specifications

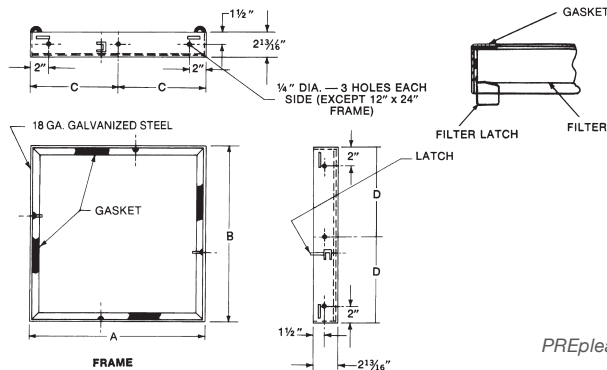

A	B	C	D
20"	20"	10"	10"
20"	25"	10"	12 1/2"
16"	20"	8"	10"
16"	25"	8"	12 1/2"
24"	24"	12"	12"
12"	24"	—	12"
20"	24"	10"	12"

VariCel®, AmerFrame®, BioCel® and DriPak® and are registered trademarks of AAF International in the U.S. and other countries. PREpleat® is a registered trademark of Flanders Corporation in the U.S.



9920 Corporate Campus Drive, Suite 2200, Louisville, KY 40223-5690  
888.223.2003 Fax 888.223.6500 | aafintl.com

AAF Flanders has a policy of continuous product research and improvement and reserves the right to change design and specifications without notice.

©2017 AAF International and its affiliated companies.

ISO Certified Firm

AFP-1-107P 01/17